

**Description**

The dual-output DFC15 Series of dc-dc converters are designed to provide a wide range of PCB power solutions where positive and negative outputs are required. The converter features fully isolated and filtered input and outputs for low noise. Trim and remote On/Off features give flexibility to designs. The ultra-wide input range, from 20 to 72 volts, allows use in most industrial and communication applications.

**Features**

- RoHS lead solder exemption compliant
- Remote on/off and trim
- Overcurrent and overtemperature protected
- Water-washable case
- Efficiencies to 82%
- 1544 V isolation
- Ultra-wide range input (>3:1)



Model Selection				
Model	Input Range VDC		Output VDC	Output mA
	Min	Max		
<b>DFC15U48D12</b>	20	72	±12	625
<b>DFC15U48D15</b>	20	72	±15	500

Model numbers highlighted in yellow or shaded are not recommended for new designs.

General Specifications (1)				
All Models				Units
<b>ON/OFF Function (2)</b>				
ON Logic Level or Leave Pin Floating	MIN	8.0	VDC	
Off Logic Level	MAX	2.0	VDC	
Input Resistance	TYP	100	Kohms	
Converter Idle Current ON/OFF Pin Low	TYP	2	mA	
<b>Isolation (3)</b>				
Breakdown Voltage 10 µA Leakage Input to Output	MIN	1544	VDC	
Input to Output Capacitance	TYP	450	pF	
<b>Output Trim Function</b>				
Input Resistance	TYP	40	Kohms	
Programming Range	MIN	+5, -34	%	
<b>Environmental</b>				
Case Functional Range, Tc No Derating	MIN MAX	-40 100	iC	
Storage Range	MIN MAX	-55 105	iC	
Thermal Impedance (4)	TYP	10	i C/Watt	
Thermal Shutdown Case Temperature	TYP	105	iC	
<b>General</b>				
MTBF (Calculated)	TYP	800,000	HRS	
Unit Weight	TYP	2.3/65	oz/gm	
Chassis Mounting Kit	CM2B2			

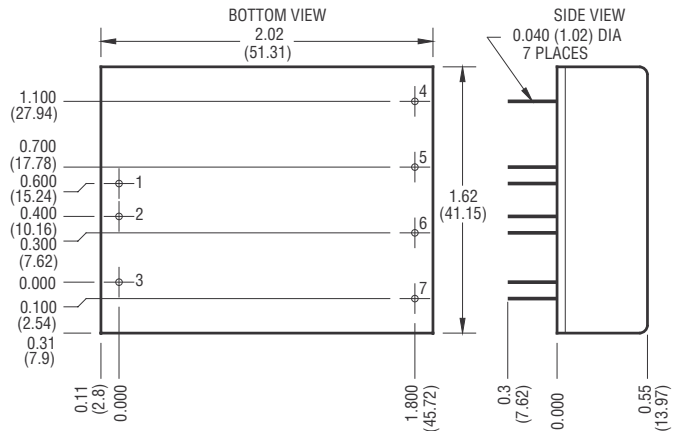

Mechanical tolerances unless otherwise noted:  
 X.XX dimensions: ±0.010 inches  
 X.XXX dimensions: ±0.005 inches

Pin	Function
1	+INPUT
2	-INPUT
3	ON/OFF
4	+OUTPUT
5	COMMON
6	-OUTPUT
7	TRIM

**Notes**

- (1) All parameters measured at Tc = 25 °C, nominal input voltage and full rated load unless otherwise noted.
- (2) The logic ON/OFF pin is Open Collector TTL, CMOS, and relay compatible. The input to this pin is referenced to Pin 2, -Input and is protected to +100 VDC.
- (3) Case is tied to Pin 1, + Input.
- (4) The case thermal impedance is specified as the case temperature rise over ambient per package watt dissipated.

Input Parameters (1)					
Model		DFC15U48D12		DFC15U48D15	Units
Voltage Range	MIN	20.0		VDC	
	TYP	48.0			
	MAX	72.0			
Reflected Ripple (2) (3)	TYP	660		mA <sub>pp</sub>	
Input Current	Full Load	TYP	384	381	mA
	No Load	TYP	5	5	
Efficiency	TYP	81	82	%	
Switching Frequency	TYP	120		kHz	
Maximum Input Overvoltage 100ms	MAX	85		VDC	
Turn-on Time, 1% Output Error	TYP	20		ms	

Output Parameters (1)					
Model		DFC15U48D12		DFC15U48D15	Units
Output Voltage		±12		±15	VDC
Rated Load Range	MIN	0		0	mA
	MAX	625		500	
Voltage Range	MIN	11.900		14.900	VDC
	TYP	12.000		15.000	
	MAX	12.100		15.100	
Load Regulation (4) 0% -100% Full Load	TYP	0.15		%	
	MAX	0.4			
Cross Regulation (5) 25%-100% Load	TYP	3.0		%	
Line Regulation Vin = Min-Max VDC	TYP	0.04		%	
	MAX	0.2			
Short Term Stability (6)	TYP	< 0.02		%/24Hrs	
Long Term Stability	TYP	< 0.2		%/kHrs	
Input Ripple Rejection (7)	TYP	>60		dB	
Noise, 0-20MHz bw (2) with 0.1µF External Capacitor	TYP	30		mV <sub>pp</sub>	
	TYP	70			
Temperature Coefficient	TYP	50		ppm/°C	
	MAX	150			
Overvoltage Clamp	TYP	18		VDC	
Short Circuit Protection to Common for all Outputs	Continuous protection with current limiting and thermal overload techniques				

### Notes

- (1) All Parameters measured at Tc=25 °C, nominal input voltage and full rated load unless otherwise noted.
- (2) Noise measurement bandwidth is 0-20 MHz.
- (3) An input capacitor must be used for proper operation of the converter. See the DFC15 Series Application Notes on sizing the input capacitor.
- (4) Load regulation for the outputs is specified as the voltage change when both outputs are changed from maximum to minimum at the same time.
- (5) Cross regulation is defined as the change in one output when the other output is changed from full load to 25% of full load. The converter can be run at no load on either or both outputs with no damage.
- (6) Short term stability is specified after a 60-minute warmup at full load, constant line and recording the drift over a 24-hour period.
- (7) The input ripple rejection is specified for DC to 120 Hz ripple with a modulation amplitude of 1% of Vin.

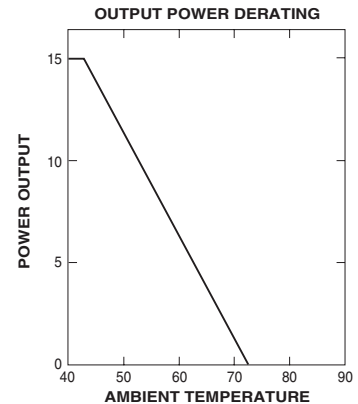
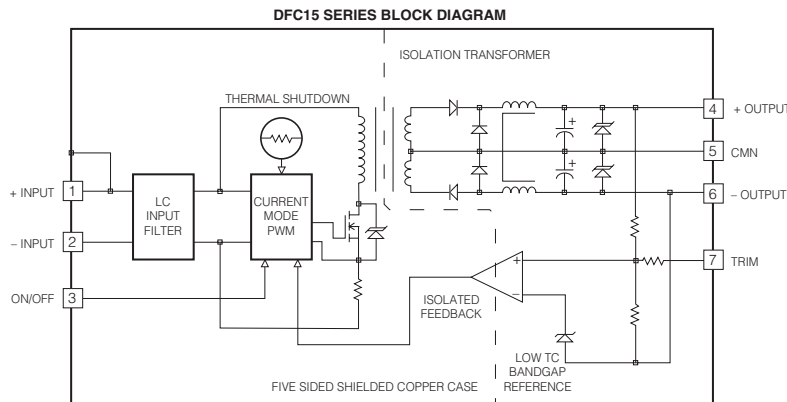

### DFC15 Series Application Notes:

#### External Capacitance Requirements

An external capacitance is required for operation of the DFC15 Series. For maximum performance, it is recommended that the DFC15 Series use a capacitor of sufficient ripple current capacity connected across the input pins. To meet the reflected ripple requirements of the converter, an input impedance of less than 0.05 Ohms from DC to 200 kHz is required. External output capacitance is not required for operation, however it is recommended that 1  $\mu$ F to 10  $\mu$ F of tantalum and 0.001 to 0.1  $\mu$ F ceramic capacitance be selected for reduced system noise. Additional output capacitance may be added for increased filtering, but should not exceed 400  $\mu$ F.

#### Remote ON/OFF Operation

The remote ON/OFF pin may be left floating if this function is not used. It is recommended to drive this pin with an open collector arrangement or a relay contact. When the ON/OFF pin is pulled low with respect to the -INPUT, the converter is placed in a low power drain state. Do not drive this input from a logic gate directly; there is a 100KV internal pull-up resistor to a 9 volt source.

#### Output TRIM

The TRIM pin may be used to adjust the output +5% to -34% from the nominal setting. This function allows adjustment for voltage drops in the system wiring. As well 5.2 volt Figure 1 shows the proper connections to use this function. A trimpot value of 10KV or a fixed resistor may be used. If the TRIM function is not required the pin may be left floating.

Typical Performance: (Tc=25°C, Vin=Nom VDC, Rated Load)

EFFICIENCY Vs. LINE INPUT VOLTAGE (12V OUTPUT)

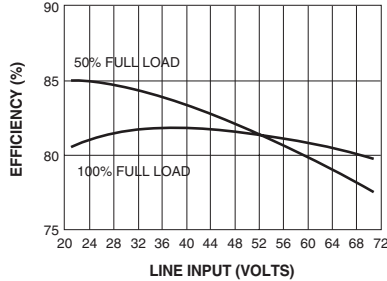

INPUT RIPPLE Vs. LINE INPUT (12V OUTPUT)

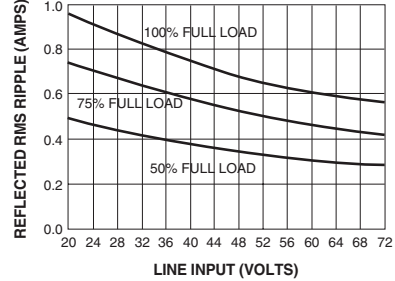

INPUT CURRENT Vs. LINE INPUT (12V OUTPUT)

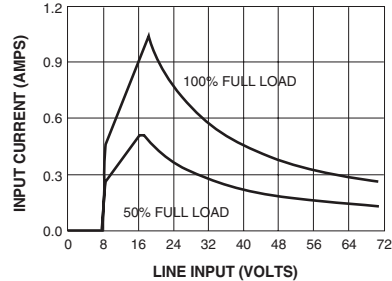

OUTPUT VOLTAGE Vs. OUTPUT LOAD (12V OUTPUT)

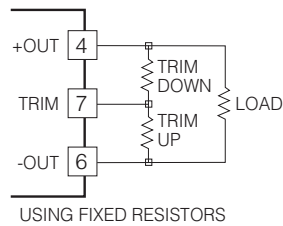
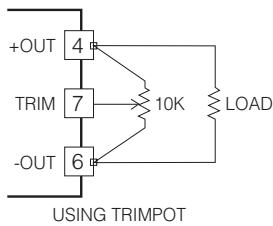
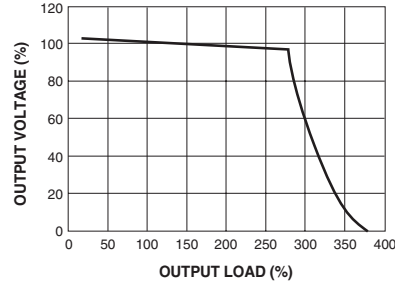
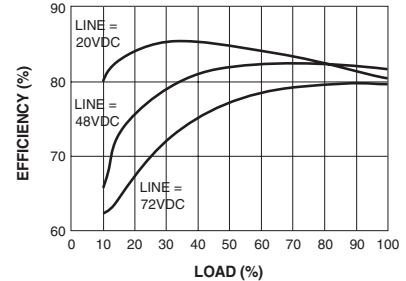

Figure 1.

EFFICIENCY Vs. LOAD (12V OUTPUT)



NUCLEAR AND MEDICAL APPLICATIONS - Power-One products are not designed, intended for use in, or authorized for use as critical components in life support systems, equipment used in hazardous environments, or nuclear control systems without the express written consent of the respective divisional president of Power-One, Inc.

TECHNICAL REVISIONS - The appearance of products, including safety agency certifications pictured on labels, may change depending on the date manufactured. Specifications are subject to change without notice.